

PM 190 25 0000

Version: 21012019

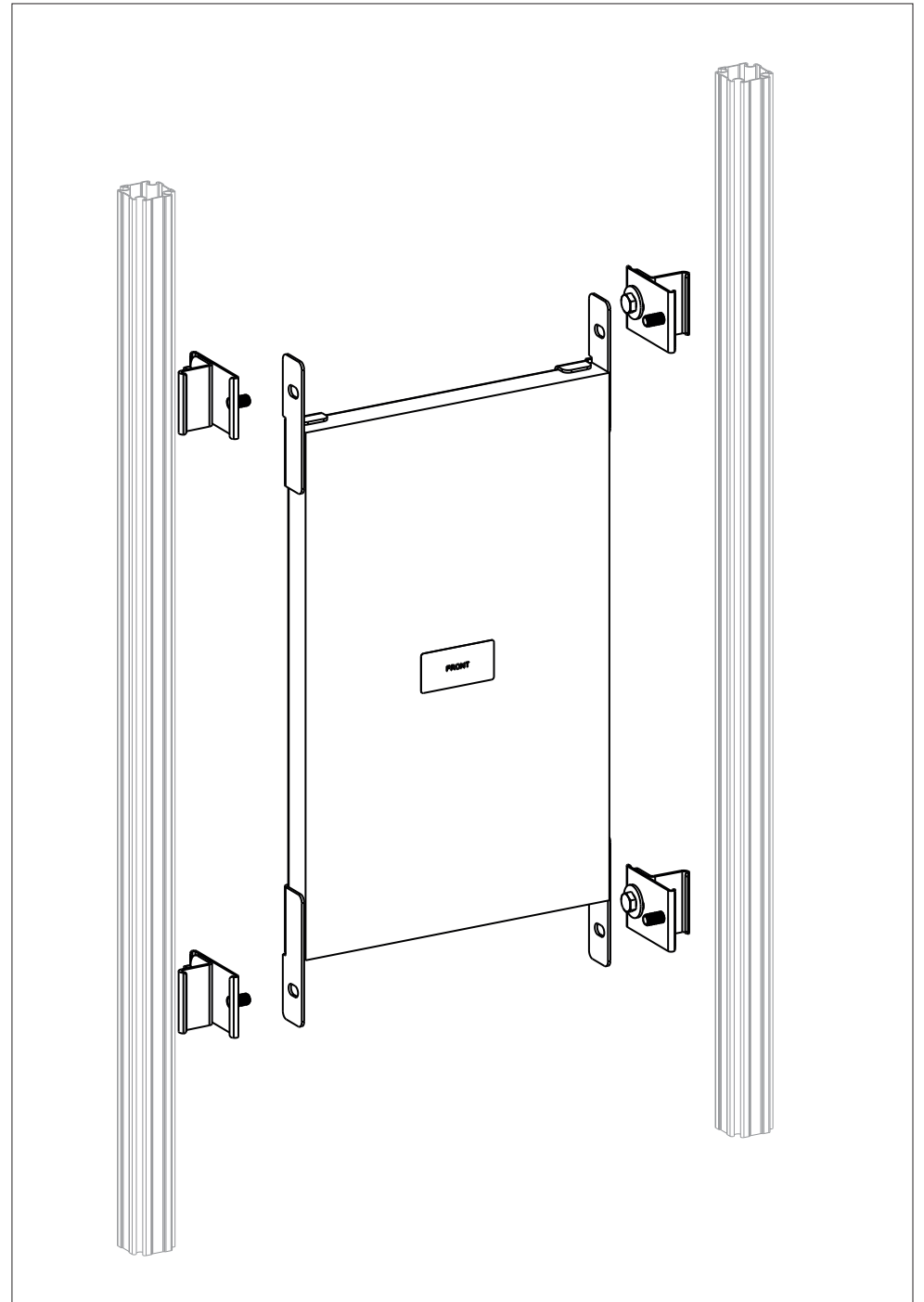

PM 190 25 0000

Version: 21012019