







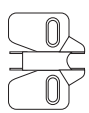
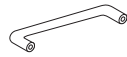

# washbox Art. 60.A00.xx..0099

<b>Nr. 1</b> 8 x 	<b>Nr. 2</b> 2 x 	<b>Nr. 3</b> 4 x 	<b>Nr. 4</b> 2 x 	<b>Nr. 5</b> 1 x 	<b>Nr. 6</b> 2 x 	<b>Nr. 7</b> 2 x 	<b>Nr. 8</b> 2 x 	<b>Nr. 9</b> 4 x 	<b>Nr. 10</b> 4 x 
4 x 16	4 x 30	8,5 x 10				5 x 55	ø 8	ø 5/ø 8	ø 8/ø 13



EM.A31.04..4500 · IX/13

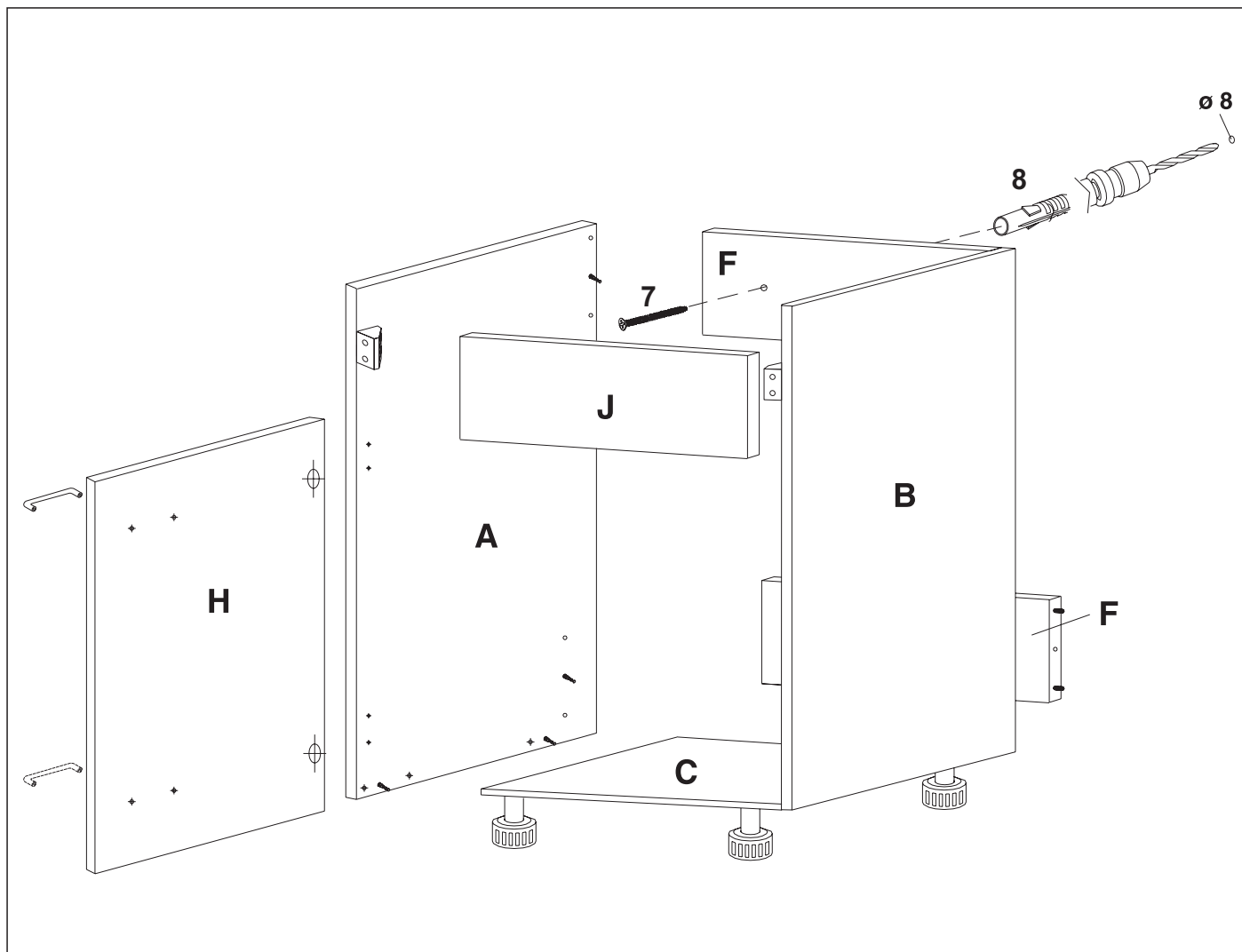